

Steckbare Printklemmen

Connecteurs enfichable

Connettori estraibile



JECOTEC
AG







JECOTEC AG - Flughafenstr. 37

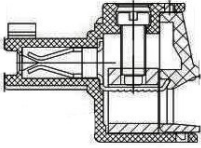

CH-8152 Glattbrugg-Zürich

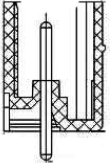

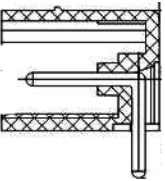

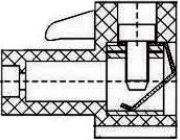
Tel. 044 810 29 08

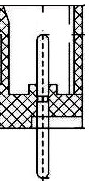

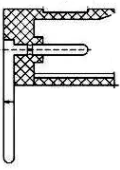
FAX. 044 810 44 82

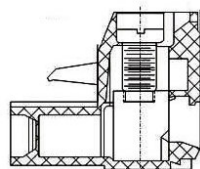
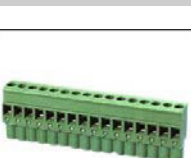
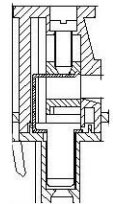
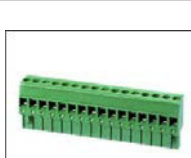
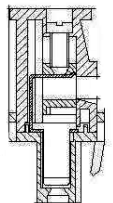

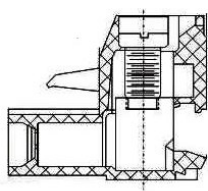

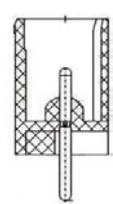

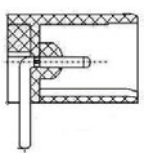
www.jecotec.ch

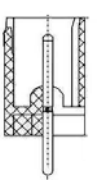

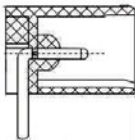

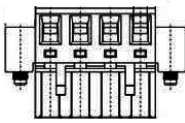
TYPE Zulassungen Approvals				Polzahl Pôles N° di Poli Poles	Raster Pas Passo Pitch		Querschnitt Section Sezione Wire Range
					mm		
KF2EDG-Y-3.50 KF2EDG-Y-3.81 CE/ UL/ VDE			Liftsystem Syst. Élévat. Sist. Ascensor. Elevat. System	2 – 24 P	3.50 3.81	8 A 300 V	0.5-1.5mm ²
KF2EDGV-Y-3.50 KF2EDGV-Y-3.81 CE/ UL/ VDE			Stiftleiste Réglettes Maschio Header	2 - 24 P	3.50 3.81	8 A 300 V	
KF2EDGR-Y-3.50 KF2EDGR-Y-3.81 CE/ UL/ VDE			Stiftleiste Réglettes Maschio Header	2 - 24 P	3.50 3.81	8 A 300 V	
HT 396 CE			Drahtschutz Languette Linguetta Wire guard	2 – 24 P	3.96	16 A 300 V	1.5 mm ²

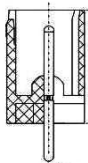

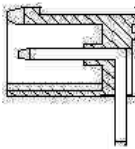

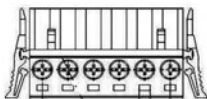

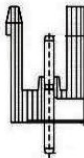

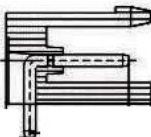

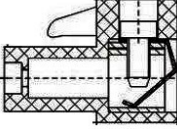

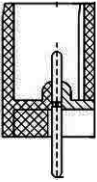
TYPE Zulassungen Approvals				Polzahl Pôles N° di Poli Poles	Raster Pas Passo Pitch		Querschnitt Section Sezione Wire Range
					mm		
HT 396 V CE			Stiftleiste Réglettes Maschio Header	2 – 24 P	3.96	16 A 300 V	
HT 396 R CE			Stiftleiste Réglettes Maschio Header	2 – 24 P	3.96	16 A 300 V	

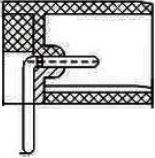
<p>2EKFKM - 500 No produce now</p>	 2EKFKM-500		<p>Liftsystem Syst. Élévat. Sist. Ascensor. Elevat. System</p>	<p>2 – 24 P</p>	<p>5.00 5.08</p>	<p>15 A 300 V</p>	<p>2.5 mm²</p>
<p>KF2EDGKB CE/ VDE</p>	 KF2EDGK-500		<p>Liftsystem Syst. Élévat. Sist. Ascensor. Elevat. System</p>	<p>2 – 24 P</p>	<p>5.00 5.08</p>	<p>15 A 300 V</p>	<p>2.5 mm²</p>
<p>KF2EDGK – 500 A CE/ VDE</p>	 KF2EDGK-500A		<p>Liftsystem Syst. Élévat. Sist. Ascensor. Elevat. System</p>	<p>2 – 24 P</p>	<p>5.00 5.08</p>	<p>15 A 300 V</p>	<p>2.5 mm²</p>
<p>KF2EDG-X-5.00 KF2EDG-X-5.08 CE/ UL/ VDE</p>	 KF2EDG-X-5.00/5.08		<p>Liftsystem Syst. Élévat. Sist. Ascensor. Elevat. System</p>	<p>2 – 24 P</p>	<p>5.00/ 5.08</p>	<p>15 A 300 V</p>	<p>2.5 mm²</p>
<p>KF2EDGV-X-5.00 KF2EDGV-X-5.08 CE/ UL/ VDE</p>	 KF2EDGV-X-5.00/5.08		<p>Stiftleiste Réglettes Maschio Header</p>	<p>2 – 24 P</p>	<p>5.00 5.08</p>	<p>15 A 300 V</p>	

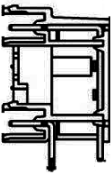
<p>TYPE Zulassungen Approvals</p>				<p>Polzahl Pôles N° di Poli Poles</p>	<p>Raste r Pas Pass o Pitch</p>		<p>Querschnitt Section Sezione Wire Range</p>
<p>KF2EDGR-X-5.00 KF2EDGR-X-5.08 CE/ UL/ VDE</p>	 KF2EDGR-X-5.00/5.08		<p>Stiftleiste Réglettes Maschio Header</p>	<p>2 – 24 P</p>	<p>5.00 5.08</p>	<p>15 A 300 V</p>	
<p>KF2EDGCV-X-5.00 KF2EDGCV-X-5.08 CE/ UL/ VDE</p>	 KF2EDGCV-X-5.00/5.08		<p>Stiftleiste Réglettes Maschio Header</p>	<p>2 – 24 P</p>	<p>5.00 5.08</p>	<p>15 A 300 V</p>	

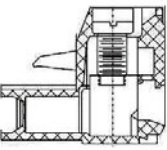
<p>KF2EDGCR-X-5.00 KF2EDGCR-X-5.08</p>	 <p>KF2EDGCR-X-5.00/5.08</p>		<p>Stiftleiste Réglettes Maschio Header</p>	<p>2 – 24 P</p>	<p>5.00 5.08</p>	<p>15 A 300 V</p>
<p>KF 222 – 500 KF 222 – 508 KF 222 – 750 KF 222 – 762</p>	 <p>KF 222-500 KF 222-508 KF 222-750 KF 222-762</p>		<p>Liftsystem Syst. Élévat. Sist. Ascensor. Elevat. System</p>	<p>2 – 24 P</p>	<p>5.00 5.08 7.50 7.62</p>	<p>15 A 300 V 2.5 mm²</p>
<p>KF 223 V – 500 KF 223 V – 508 KF 223 V – 750 KF 223 V – 762</p>	 <p>KF 223V-500 KF 223V-508 KF 223V-750 KF 223V-762</p>		<p>Stiftleiste Réglettes Maschio Header</p>	<p>2 – 24 P</p>	<p>5.00 5.08 7.50 7.62</p>	<p>15 A 300 V</p>
<p>KF 223 R – 500 KF 223 R - 508 KF 223 R – 750 KF 223 R – 762</p>	 <p>KF 223R-500 KF 223R-508 KF 223R-750 KF 223R-762</p>		<p>Stiftleiste Réglettes Maschio Header</p>	<p>2 – 24 P</p>	<p>5.00 5.08 7.50 7.62</p>	<p>15 A 300 V</p>

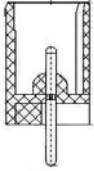
<p>KF 220 – 508 NO PRODUCE NOW</p>	 <p>KF220-508</p>		<p>Liftsystem Syst. Élévat. Sist. Ascensor. Elevat. System</p>	<p>2 – 24 P</p>	<p>5.08</p>	<p>15 A 300V</p>	<p>2.5 mm²</p>
<p>KF 221 V – 508 NO PRODUCE NOW</p>	 <p>KF221V</p>		<p>Stiftleiste Réglettes Maschio Header</p>	<p>2 – 24 P</p>	<p>5.08</p>	<p>15 A 300 V</p>	
<p>KF 221 R – 508 NO PRODUCE NOW</p>	 <p>KF221R</p>		<p>Stiftleiste Réglettes Maschio Header</p>	<p>2 – 24 P</p>	<p>5.08</p>	<p>15 A 300 V</p>	

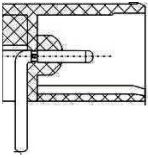
TYPE Zulassungen Approvals				Polzahl Pôles N° di Poli Poles	Raster Pas Passo Pitch mm		Querschnitt Section Sezione Wire Range
HT 508 CE	 HT508		Drahtschutz Languette Linguetta Wire guard	2 – 24 P	5.08	10 A 300 V	2.5 mm ²
HT 508 V CE	 HT508V		Stiftleiste Réglettes Maschio Header	2 – 24 P	5.08	10 A 300 V	
HT 508 R CE	 HT508R		Stiftleiste Réglettes Maschio Header	2 – 24 P	5.08	10 A 300 V	
KF 1026 R CE			Stiftleiste Réglettes Maschio Header	2 x 2 P 2 x 3 P – 2 x 24 P	5.00 5.08	15 A 300 V	
KF2EDG-X-7.50 KF2EDG-X-7.62 CE/ UL/ VDE			Liftsystem Syst. Élévat. Sist. Ascensor. Elevat. System	2 – 24 P	7.62	15 A 300 V	2.5 mm ²
KF2EDGV-X-7.50 KF2EDGV-X-7.62 CE/ UL/ VDE			Stiftleiste Réglettes Maschio Header	2 - 24 P	7.50 7.62	15 A 300 V	
KF2EDGR-X-7.50 KF2EDGR-X-7.62 CE/ UL/ VDE			Stiftleiste Réglettes Maschio Header	2 - 24 P	7.50 7.62	15 A 300 V	

